

PW172KB

Universal 15 – 19 Watt Series

ITE Switch-Mode Power Supply



3 Year Warranty

- 100-240VAC Universal Input
- Desktop and Wall-Plug Style with either fixed blades, or Interchangeable Blades* (Kit sold separately)
- 5V to 48V Single Output Models, up to 19W
- Modified and Custom Designs Available
- Regulated Output with Low Ripple
- Impact-Resistant Polycarbonate Enclosure
- No load Power Consumption < 0.5W
- Meets EISA Requirements (see next page for details).
- Meets Energy Star Level IV



International Safety Standard Approvals



Specifications

All Specifications are typical at nominal input, full load at 25°C unless otherwise stated.

AC Input 100-240VAC, +/-10% (class I), +6%, -10% (class II), 47-63 Hz, 1Ø.	MTBF >100,000 hours (calculated)
Input Current 90VAC: 0.5A	Hold-up Time 18 ms min. @ 115VAC
Inrush Current Inrush limiting provided.	Overvoltage Protection Built-in
Input Fuses Internal Primary Current Fuse is provided.	Overload Protection Hiccup Mode
Efficiency Meet EISA Requirements – see page 2	Short Circuit Protection Hiccup Mode
Output Voltage See chart.	Topology Switching – Fixed Frequency Flyback
Output Power See chart	Approvals and Safety Standards EN/IEC/CSA/UL60950-1, EMC: EN55022/55024/61000
Ripple and Noise 1% pk-pk max., 20MHz BW	Dielectric Withstand Input-Output: 3000VAC, Input-GND: 1500VAC, Output-GND: 500VDC
Line & Load Voltage Regulation Excluding Cord: Line: +/- 1%, Load: +/-5%.	Operating Temperature 0° to 40°C, no derating
Transient Response 500µs max., 50% load step, typical	Storage Temperature -30 to +85°C.
Minimum Load Not required.	Relative Humidity 5% to 95%, non-condensing
Case Material: Black 94V0 Polycarbonate	Altitude 0 to 10,000 ft.
Case Dimensions: See outline drawing.	Output Connections: Cable: 18AWG, 1800mm (5V & 6V models: 1500mm), 2 conductor. Connector: 2.5mm barrel type (Ault #3) connector, center contact (+). Other connector options are available.

Model Number Key

PW172 K B 12 03 F 01

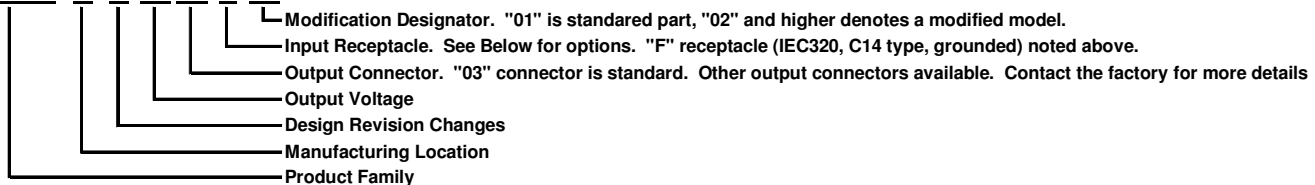

PW172KB

Universal 15-19 Watt Series

ITE Switch Mode Power Supply

3 Year Warranty

Model Number	Volts (V)	Output Current (max)	Max Watts	Ripple (Vp-p max)
PW172KB0503F01	5 V	3.00 A	15.0 W	50mV
PW172KB0603F01	6 V	2.50 A	15.0 W	60mV
PW172KB0903F01	9 V	2.00 A	18.0 W	90mV
PW172KB1203F01	12 V	1.50 A	18.0 W	120mV
PW172KB1503F01	15 V	1.20 A	18.0 W	150mV
PW172KB1803F01	18 V	1.00 A	18.0 W	180mV
PW172KB2403F01	24 V	0.75 A	18.0 W	240mV
PW172KB4803F01	48 V	0.40 A	19.2 W	480mV

Note: Part numbers above include #3 output connector and IEC320 C14 grounded input receptacle. See below for other options.

DESKTOP OPTIONS			WALL-PLUG OPTIONS				
IEC320 C14 Grounded (F)	IEC320 C18 Ungrounded (Q)	IEC320 C8 "Shaver" (N)	N. America Japan Interchangeable (B)	N. America Japan Fixed (C)	Europe Fixed (M)	United Kingdom Fixed (G)	Australia Fixed (H)

Notes:

- For Desktop options, choose the applicable letter above.
- For Wall-plug options, choose the applicable letter above. The model will then be fitted only with the receptacle chosen. The North American blade version (B) will be an interchangeable blade. The other options (C), (M), (G), and (H), will be fixed blades molded in the case.
- Blade Kit is available which will include one each of a EU, UK, and Aust blade. Kit part number is KT1027K. Can be used with (B) version only, to allow blades to be interchanged.

Output Connector

Notes:

- Ault #3 Connector
- Center Contact = Positive
- Connector is Switchcraft 760 plug or equivalent.
- Suggested Mating Connector is Switchcraft 712A jack or equivalent.
- Other output connector options are available. Contact your local representative for details.

2007 Energy Independence and Security Act - EISA

The Energy Independence and Security Act of 2007 was passed in December of 2007 and addresses minimum efficiency standards and standby levels for Class A external power supplies that are 250 Watts and under. This law stipulates that external power supplies manufactured on July 1, 2008 and beyond meet certain minimum efficiency and standby criteria as defined below.

Minimum Efficiency Criteria:

Active mode is defined as when a power supply's input is connected to a line voltage AC and it's output is connected to a DC or AC load, drawing a portion of the product's power output. Depending upon the power rating for the power supply, it must meet the minimum efficiency criteria outlined below.

Energy-Efficiency Criteria for Active Mode:

Output Power on Adapter Label
 0 to < 1 Watt
 > 1 watt to ≤ 51 watts
 > 51 watts

Minimum Average Efficiency Percentage
 ≥ 0.50 * output power on the label
 ≥ [0.09 * Ln (output power on adapter label)] + 0.50
 ≥ 0.85

Energy Consumption Criteria for No Load Mode:

The power supply must also meet a requirement for when its input is connected to line voltage AC but its output is not connected to a load. Depending upon the power output of the supply, it must keep its energy consumption below the following values:

Output Power on Adapter Label
 0 to < 250 Watts

Maximum Power Consumption in No-Load Mode
 ≤ 0.50 watts

PW172KB

Universal 15-19 Watt Series

ITE Switch Mode Power Supply

3 Year Warranty

Outline Drawings

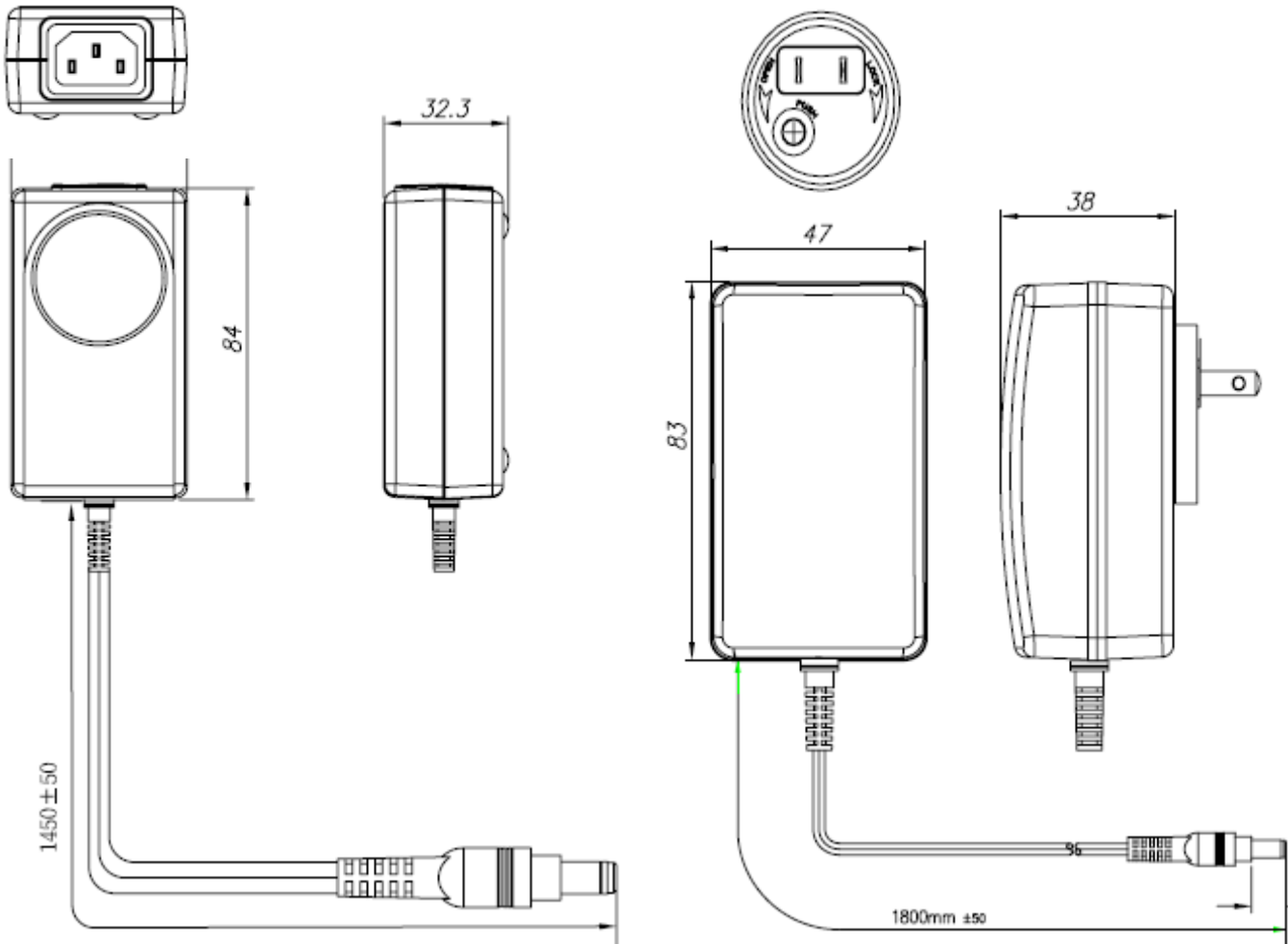

Dimensions are in mm

[Desktop Style \(Option "F" shown\)](#)

[Wallplug Style \(Option "B" shown\)](#)